

# PlateRite 8600N/8300N

Thermal Plate Recorders



Creating a Future in Print

## Advanced CtP units that make high-performance CtP output a reality in your production environment

The high-performance B1-format PlateRite 8600N/8300N thermal plate recorders feature Screen's unique external drum imaging technology combined with high-precision optics. These units boast cutting-edge functions that take full advantage of the high quality offered by thermal plates. They can also be paired with a variety of automated systems that enable long periods of unmanned operation, facilitating timely plate delivery and contributing significantly to higher press operating ratios.



### PlateRite 8600N-Z/S/E

The PlateRite 8600N-Z/S/E are standard thermal CtP recorders that output B1-size plates. The PlateRite 8600N-Z and PlateRite 8600N-S feature a 64-channel light source that makes it possible to output 23 B1-size plates per hour. The PlateRite 8600N-E features a 32-channel light source and can output up to 14 B1-size plates per hour.

### PlateRite 8300N-S/E

The PlateRite 8300N-S/E are entry-level thermal CtP recorders that output B1-size plates. The PlateRite 8300N-S is equipped with a 32-channel light source and can output 14 B1-size plates per hour. The more economical PlateRite 8300N-E utilizes a 16-channel light source and can output up to 8 B1-size plates per hour.

### Upgrade to create the optimal CtP environment

The PlateRite 8600N/8300N units all have certain parts that can be replaced to upgrade them to higher model types (upgrade is a paid option). These flexible recorders can be upgraded as productivity needs change to create an optimal production environment.

#### High resolution

The PlateRite 8600N-Z delivers high-resolution 4,000 dpi support. This is perfect for everything from high-resolution art printing to the accurate reproduction of small text sizes like those required for bond and other certificate printing.

This also enables the PlateRite 8600N-Z to output high-quality 4,000 dpi 3D lenticular printing plates.

#### Productivity (1,030 x 800 mm [40.5" x 31.4"] plates, at 2,400 dpi)

|                   | Light source<br>(Laser diodes) | Productivity |
|-------------------|--------------------------------|--------------|
| PlateRite 8600N-Z | 64ch                           | 23 Plate/hr  |
| PlateRite 8600N-S | 64ch                           | 23 Plate/hr  |
| PlateRite 8600N-E | 32ch                           | 14 Plate/hr  |
| PlateRite 8300N-S | 32ch                           | 14 Plate/hr  |
| PlateRite 8300N-E | 16ch                           | 8 Plate/hr   |

# A full range of advanced features that support high quality and high productivity

## Stable drum rotation

The PlateRite 8600N/8300N feature a unique auto-balancing feature. The operator simply selects the appropriate pre-registered plate size and type during setup, and the recorder automatically makes the necessary adjustments to ensure perfect drum balance. This results in stable, high-speed drum rotation for all the plate sizes and thicknesses handled by the recorder.

## Maximized available image area

The minimum clamp size that can be used with the PlateRite 8600N/8300N is 8 mm, for both the leading and trailing edge clamps.

The available imaging area is extremely large, so plates can be used for a wide range of printing press types. This helps reduce the amount of effort involved in plate handling and increases printing press operating ratios, thereby contributing significantly to increased productivity.

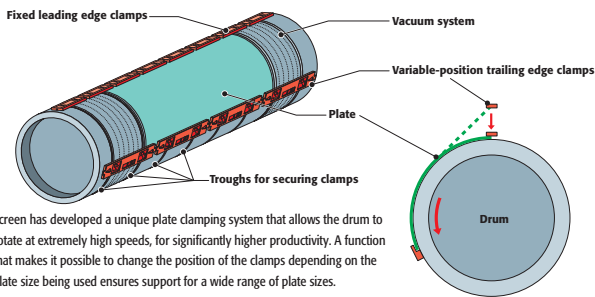

Screen has developed a unique plate clamping system that allows the drum to rotate at extremely high speeds, for significantly higher productivity. A function that makes it possible to change the position of the clamps depending on the plate size being used ensures support for a wide range of plate sizes.

## Check operation status at a glance

The PlateRite 8600N/8300N models come standard with a signal light at the top of the unit that makes it easy to check CtP operation status and see if any errors have occurred. An optional signal tower that improves visibility regardless of the operator's position is also available.

### Signal light

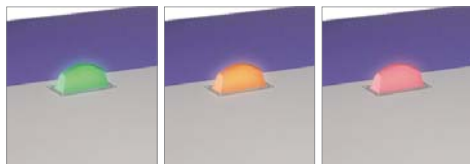

Normal operation

Awaiting instructions

Error

### Signal tower



## Superior registration accuracy

The PlateRite 8600N/8300N feature an automatic inline punching system that helps enable perfect registration on press. Plates are punched by this automatic inline punching system immediately before being loaded onto the drum. The registration punch holes ensure consistent plate placement on the drum, when used in conjunction with standard registration pins. This helps eliminate imaging variations caused by improper plate placement, and ensures superior registration accuracy.

When optional printing press punch blocks\*1 are used, the imaged plates can be loaded directly onto the press after output. The use of printing press punch blocks during plate output eliminates the need for manual punching later on in the workflow, ensures excellent registration accuracy, and creates the foundation for perfect results on press. It also dramatically shortens press make-ready time and improves press operating ratios, for even better overall productivity.

\*1 Up to eight individual punch blocks can be selected and mounted, depending on the plate sizes and printing press types being used.



## Regular monitoring of production status from a remote location

Remote monitoring allows users to keep an eye on CtP operating conditions and output history from a remote location, using a web browser or e-mail. E-mails can also be sent automatically to the service center and entered into a database for use in maintenance, repairs, and periodic inspections, ensuring that the CtP recorder is in optimal operating condition at all times.

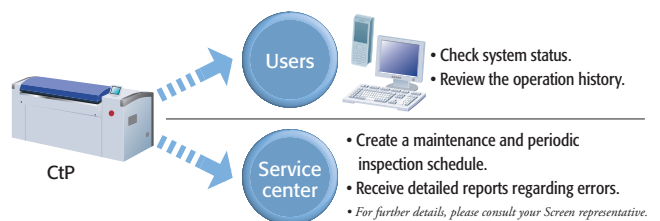

## Improved productivity with automation of everything from plate loading to delivery

The PlateRite 8600N/8300N units can be used with auto-loaders that automate plate loading, imaging, transport, developing, and delivery. These auto-loaders enable long periods of continuous production and contribute significantly to improved productivity and better printing press operating ratios.



MA-L8800N

Processor bridge completes automated line, and is compatible with major processor types

Automatic punching by the printing press punch

Innovative plate handling system prevents damage to the front of the plate during transport

Sensor automatically detects plate/interleaf paper

Automatic delivery of interleaf paper to interleaf paper collection box

Up to 5 cassettes, each with up to 100 plates  
Up to 5 different plate sizes (or all same)  
Maximum of 500 plates loaded without operator intervention

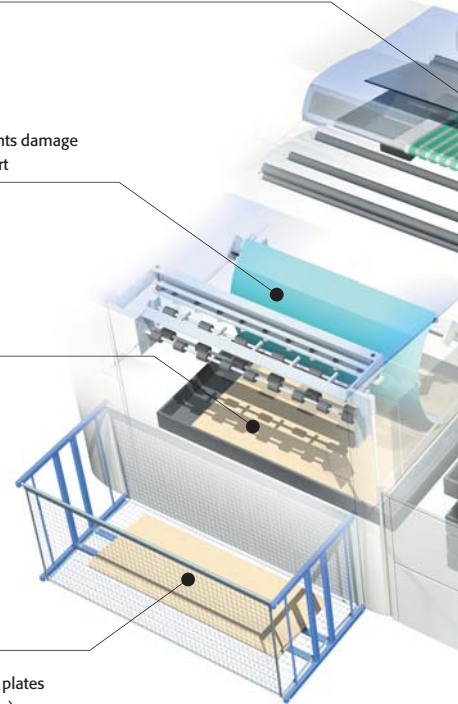

## Customize your system by choosing anything from semi-automatic to fully automatic plate

### SA-L8800N single-cassette autoloader (option)

The SA-L 8800N single-cassette autoloader can hold up to 100 plates, which makes long periods of continuous unmanned operation possible. It automatically removes interleaf paper and sends it to an external collection box just before each plate is loaded. No contact is made with the sensitive emulsion side of the plate at any stage during transport, eliminating the risk of damage to the plate. Manual loading is also possible, providing the flexibility to use different sized plates whenever required.

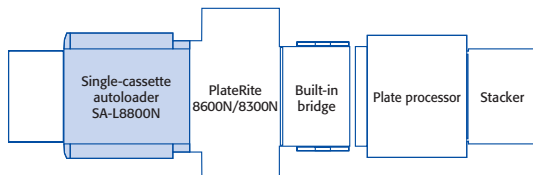

|                            | PlateRite 8600N, PlateRite 8300N     |
|----------------------------|--------------------------------------|
| Single-Cassette autoloader | SA-L8800N                            |
| Multi-Cassette autoloader  | MA-L8800N                            |
| Processor bridge           | Built-in bridge, AT-T8001R, AT-M8001 |

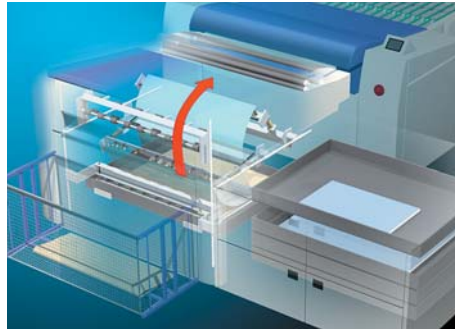
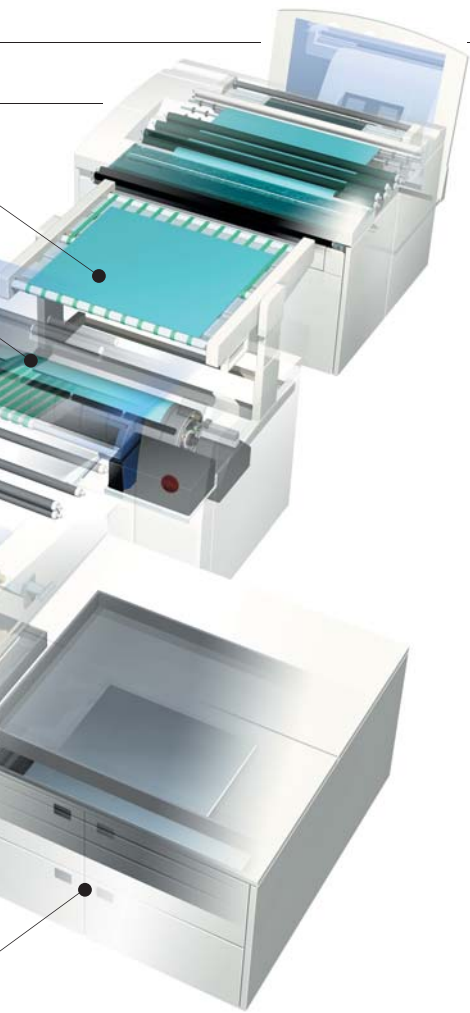

**1** The arm goes to pick up the plate, and the plate is hoisted up to the engine section.

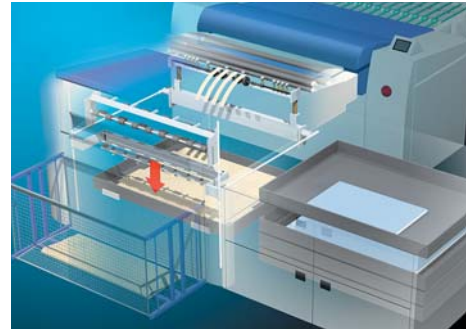

**2** The interleaf paper adheres to the suction pads and is removed.

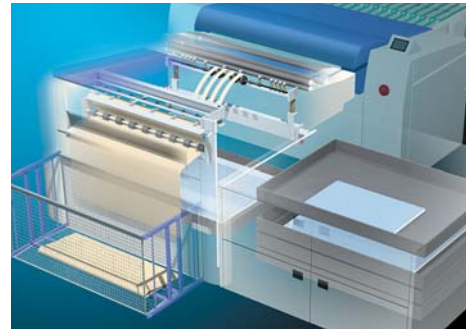

**3** The interleaf paper is lifted away and ejected into an external collection box.

## handing

### MA-L8800N multi-cassette autoloader (option)

The MA-L8800N multi-cassette autoloader enables complete automation of the cassette changing and plate loading processes. It is attached as an extension to the single-cassette autoloader. It comes standard with three cassettes, with each cassette holding up to 100 plates. An additional two cassettes are available as an option. The use of five cassettes enables automatic switching between up to 500 plates of five different sizes, as necessary for the job at hand. When the same size of plate is loaded in each cassette, extremely long periods of unmanned operation are possible.

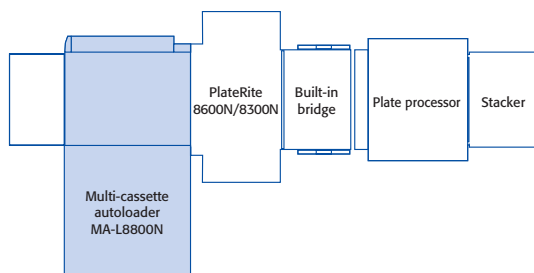

### Multi-bridge AT-M8001

The AT-M8001 is a multi-bridge that can connect the PlateRite 8600N/8300N to multiple plate processors. It allows you to connect the PlateRite 8600N/8300N to two different plate processors and then switch the transport line between them as necessary to process different types of plates at different plate processors. It's also possible to set the transport line up in an L-shape. The flexibility to select the L-shape layout is particularly useful when a straight-line layout is not possible due to space constraints, or if a small automatic plate processor is used.

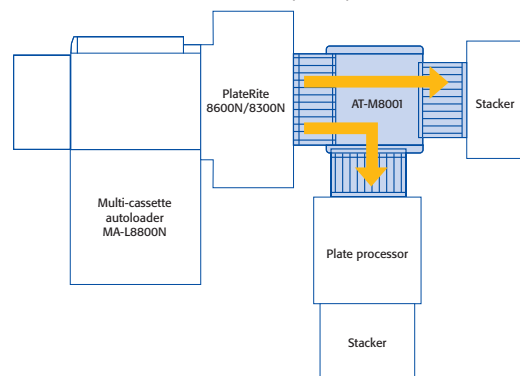

## Dimensions

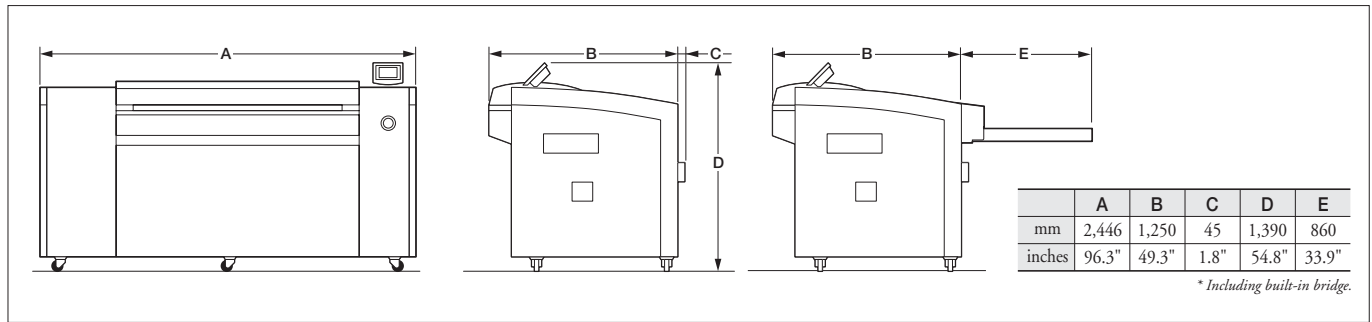

## PlateRite 8600N-Z/S/E specifications

|                            | PlateRite 8600N-Z  | PlateRite 8600N-S  | PlateRite 8600N-E       |
|----------------------------|--|--|-------------------------|
| Recording system           | External drum  |  |                         |
| Light source               | 64-channel laser diodes  |  | 32-channel laser diodes |
| Plate size                 | Maximum: 1,160 x 940 mm (45.6" x 37"); Minimum: 304 x 370 mm (12" x 14.6")   |  |                         |
| Exposure size              | Maximum: 1,160 x 924 mm (45.6" x 36.3") <sup>*1</sup>  |  |                         |
| Media                      | Thermal plates   |  |                         |
| Media thickness            | 0.15 to 0.3 mm (5.9 to 11.8 mil) [0.4 mm (15.7 mil) available as an option]  |  |                         |
| Resolutions                | 1,200 <sup>*2</sup> /2,000 <sup>*2</sup> /2,400/2,438/2,540/4,000 dpi  | 1,200 <sup>*2</sup> /2,400/2,438/2,540 dpi                         |                         |
| Repeatability              | ± 5 microns <sup>*3</sup>  |  |                         |
| Productivity <sup>*4</sup> | 23 plates/hr at 2,400 dpi<br>(1,030 x 800 mm/40.5" x 31.4" plates)   | 14 plates/hr at 2,400 dpi<br>(1,030 x 800 mm/40.5" x 31.4" plates) |                         |
| Interface                  | F-PIF  |  |                         |
| Plate transport            | Semi-automatic loading (standard), Fully-automatic loading (optional), Plate transport system (optional)   |  |                         |
| Punch systems              | Screen, Heidel, Heidelberg W, Protocol, Komori, and others   |  |                         |
| Dimensions (W x D x H)     | Main unit: 2,446 x 1,295 x 1,390 mm (96.3" x 51" x 54.8"); Blower unit: 693 x 675 x 550 mm (27.3" x 26.6" x 21.7")   |  |                         |
| Weight                     | Main unit: 1,150 kg (2,530 lb); Blower unit: 85 kg (187 lb)  |  |                         |
| Power requirements         | Main unit: Single phase 220 V to 240 V, 32A, 4 kW (Approved UL, CSA, Declared CE)<br>(SA-L, MA-L, AT-T, AT-M, and blower unit are supplied by main unit.)  |  |                         |
| Environment                | Recommended: 21 to 25°C (69.8 to 77°F);<br>Required: 18 to 26°C (64.4 to 78.8°F); Relative humidity: 40 to 70% (no condensation)   |  |                         |
| Options                    | SA-L8800N, MA-L8800N, feed tray, plate transport system (built-in bridge, AT-T8001R, AT-M8001), various printing press punches, support for 0.4 mm thickness, optional registration punch (600) <sup>*5</sup> , signal tower unit. |  |                         |

<sup>\*1</sup>. A 24-mm portion remains unexposed when 12-mm clamps are used. A 16-mm portion remains unexposed when 8-mm clamps are used. Productivity is different when 8-mm clamps are used.

<sup>\*2</sup>. 1,200 dpi uses 2,400 dpi double dots. 2,000 dpi uses 4,000 dpi double dots. <sup>\*3</sup>. Over four consecutive exposures on one plate at 23°C (73.4°F) and 60% relative humidity.

<sup>\*4</sup>. Productivity may vary depending on the sensitivity of the media. <sup>\*5</sup>. Required for plates 590 mm (23.3") or wider, but less than 610 mm (24") wide.

## PlateRite 8300N-S/E specifications

|                            | PlateRite 8300N-S   | PlateRite 8300N-E   |
|----------------------------|---|---|
| Recording system           | External drum   |   |
| Light source               | 32-channel laser diodes   | 16-channel laser diodes   |
| Plate size                 | Maximum: 1,160 x 940 mm (45.6" x 37"); Minimum: 304 x 370 mm (12" x 14.6")  |   |
| Exposure size              | Maximum: 1,160 x 924 mm (45.6" x 36.3") <sup>*1</sup>   |   |
| Media                      | Thermal plates  |   |
| Media thickness            | 0.15 to 0.3 mm (5.9 to 11.8 mil) [0.4 mm (15.7 mil) available as an option]   |   |
| Resolutions                | 1,200 <sup>*2</sup> /2,000/2,400/2,438/2,540/4,000 <sup>*3</sup> dpi  | 2,400/2,438/2,540 dpi<br>(1,200 dpi <sup>*2</sup> output is also supported by upgraded PlateRite 8300 units.) |
| Repeatability              | ± 5 microns <sup>*4</sup>   |   |
| Productivity <sup>*5</sup> | 14 plates/hr at 2,400 dpi<br>(1,030 x 800 mm/40.5" x 31.4" plates)  | 8 plates/hr at 2,400 dpi<br>(1,030 x 800 mm/40.5" x 31.4" plates)   |
| Interface                  | F-PIF   |   |
| Plate transport            | Semi-automatic loading (standard), Fully-automatic loading (optional), Plate transport system (optional)  |   |
| Punch systems (optional)   | Screen, Heidel, Heidelberg W, Protocol, Komori, and others  |   |
| Dimensions (W x D x H)     | Main unit: 2,446 x 1,295 x 1,390 mm (96.3" x 51.0" x 54.8")<br>Blower unit: 693 x 675 x 550 mm (27.3" x 26.6" x 21.7")  |   |
| Weight                     | Main unit: 1,150 kg (2,530 lb); Blower unit: 85 kg (187 lb)   |   |
| Power requirements         | Main unit: Single phase 220 V to 240 V, 32A, 4 kW (Approved UL, CSA, Declared CE)<br>(SA-L, MA-L, AT-T, AT-M, and blower unit are supplied by main unit.)   |   |
| Environment                | Recommended: 21 to 25°C (69.8 to 77°F);<br>Required: 18 to 26°C (64.4 to 78.8°F); Relative humidity: 40 to 70% (no condensation)  |   |
| Options                    | SA-L8800N, MA-L8800N, feed tray, plate transport system (built-in bridge, AT-T8001R, AT-M8001) <sup>*6</sup> , various printing press punches, support for 0.4 mm thickness, optional registration punch (600) <sup>*7</sup> , signal tower unit. |   |

<sup>\*1</sup>. A 24-mm portion remains unexposed when 12-mm clamps are used. A 16-mm portion remains unexposed when 8-mm clamps are used. Productivity is different when 8-mm clamps are used.

<sup>\*2</sup>. 1,200 dpi uses 2,400 dpi double dots. <sup>\*3</sup>. When outputting at 4,000 dpi, confirm output quality before use. <sup>\*4</sup>. Over four consecutive exposures on one plate at 23°C (73.4°F) and 60% relative humidity.

<sup>\*5</sup>. Productivity may vary depending on the sensitivity of the media. <sup>\*6</sup>. PlateRite 8300N-E (included upgraded model) requires the rear delivery kit.

<sup>\*7</sup>. Required for plates 590 mm (23.3") or wider, but less than 610 mm (24") wide.

## Autoloader specifications

|                        | SA-L8800N  | MA-L8800N  |
|------------------------|--|--|
| Compatible models      | PlateRite 8600N, PlateRite 8300N   |  |
| Plate transport        | Fully automated (automatic interleaf paper removal)  |  |
| Cassette capacity      | 100 plates   | 100 plates per cassette  |
| No. of cassettes       | —  | Up to 5 cassettes (3 cassettes standard)   |
| Dimensions (W x D x H) | 1,758 x 1,806 x 1,280 mm (69.3" x 71.2" x 50.4")   | 3,213 x 1,806 x 1,280 mm (126.5" x 71.2" x 50.4")  |
| Weight* <sup>2</sup>   | 600 kg (1,320 lb)  | 1,250 kg (2,750 lb)  |
| Power requirements     | Supplied by main unit  |  |
| Environment            | Recommended: 21 to 25°C (69.8 to 77°F);<br>Required: 18 to 26°C (64.4 to 78.8°F); Relative humidity: 40 to 70% (no condensation) |  |
| Standard accessories   | 1 carrier-type cassette, interleaf paper disposal box  | Interleaf paper disposal box   |
| Options                | Additional carrier-type cassettes (with dustproof covers),<br>304 mm small plate tray* <sup>3</sup>                              | Additional cassettes (with cassette trays and driver motors),<br>304 mm small plate tray* <sup>3</sup> |

\*1. Cassette capacity may vary with plates that are 0.3 mm (11.8 mil) thick or thicker, or less than 450 mm (17.8") wide.

\*2. Not including the weight of the plates. \*3. Required when using plates under 450 mm in width.

## AT-M8001 plate transport system specifications

|                        |   |
|------------------------|---|
| Dimensions (W x D x H) | 2,150 x 1,655 x 955 mm (84.7" x 65.2" x 37.6")  |
| Weight                 | 180 kg (396 lb)   |
| Power requirements     | Supplied by main unit   |
| Environment            | Recommended: 21 to 25°C (69.8 to 77°F); Required: 18 to 26°C (64.4 to 78.8°F); Relative humidity: 40 to 70% (no condensation) |
| Options                | Left-turn transport layout, straight-line transport bridge  |

[www.screen.co.jp/ctp\\_no1](http://www.screen.co.jp/ctp_no1)

For more information, please visit our web site.  
You can see product movie on it!



## DAINIPPON SCREEN MFG. CO., LTD.

### HEAD OFFICE

• Teranouchi-agaru 4-chome, Horikawa-dori, Kamigyo-ku, Kyoto, 602-8585 Japan/Phone +81-75-414-7610/Fax +81-75-414-7608

### DAINIPPON SCREEN GRAPHICS (USA),LLC

• 5110 Tollview Dr, Rolling Meadows, IL 60008, USA/Phone +1-847-870-7400/Fax +1-847-870-0149 [www.screenusa.com](http://www.screenusa.com)

### DAINIPPON SCREEN (DEUTSCHLAND) GmbH

• Mündelheimer Weg 39, 40472 Düsseldorf, Germany/Phone +49-211-472701/Fax +49-211-4727199

### DAINIPPON SCREEN (U.K.) LTD.

• Michigan Drive, Tongwell, Milton Keynes, Buckinghamshire MK15 8HT, UK/Phone +44-1908-848500/Fax +44-1908-848501 [www.screen.co.uk](http://www.screen.co.uk)

### DAINIPPON SCREEN (NEDERLAND) B.V.

• Bouwerij 46, 1185 XX Amstelveen, Holland/Phone +31-20-4567800/Fax +31-20-4567805 [www.screen-europe.com](http://www.screen-europe.com)

### DAINIPPON SCREEN SINGAPORE PTE. LTD.

• 29, Kaki Bukit View, Kaki Bukit Technopark II, Singapore 415963/Phone +65-6749-3833/Fax +65-6749-9010 [www.screen-sp.com.sg](http://www.screen-sp.com.sg)

### DAINIPPON SCREEN (CHINA) LTD.

• Room 2001 - 2003, 20/F Cable TV Tower 9 Hoi Shing Road Tsuen Wan, N.T. Hong Kong/Phone +852-2953-0038/Fax +852-2755-8683

Beijing office/Phone +86-10-6708-9271, 9272, 9273/Fax +86-10-6708-9395

Shanghai office/Phone +86-21-3126-5122/Fax +86-21-5218-2199

Guangzhou office/Phone +86-20-3891-1112/Fax +86-20-3891-1036

### DAINIPPON SCREEN (TAIWAN) CO., LTD.

• 4F No. 126-1, Ming Tsu West Rd., Taipei, Taiwan/Phone +886-2-25862711/Fax +886-2-25914367

### DAINIPPON SCREEN (KOREA) CO., LTD.

• 10th Yonsei Bongsae B/D 48-3, 1Ga, Bongsae-Dong, Joong-Gu, Seoul 100-161, Korea/Phone +82-2-7766-786/Fax +82-2-7766-787

### DAINIPPON SCREEN (AUSTRALIA) PTY. LTD.

• Suite 11, 2 Eden, Park Drive, Macquarie, NSW2133, Australia/Phone +61-2-9016-3400/Fax +61-2-9016-3425

Internet web site : [www.screen.co.jp](http://www.screen.co.jp)  
[www.screenusa.com](http://www.screenusa.com)  
[www.screen-europe.com](http://www.screen-europe.com)

• This brochure was made using SPEKTA 2 screening.

We reserve the right to alter product design and specifications without prior notice.